

### About the voltage difference between battery strings after equalization:

1. The min voltage difference of 824 series design is  $\leq 30\text{mV}$  (actually  $15\sim 20\text{mV}$ );
2. The min voltage difference after equalization is related to the equalization time.  
The longer the equalization time is, the smaller the pressure difference is;
3. The minimum voltage difference after equalization is related to the battery internal resistance, connecting line resistance and connector resistance. The smaller the resistance is, the smaller the pressure difference is.

### About the voltage difference between battery strings after equalization:

The 824 equalizer adopts the high-frequency transformer inversion and equipotential isolation coupling energy mode to realize the parallel connection of each series of batteries through the equipotential isolation coupling mode. Based on the parallel connection state, each series of batteries with different voltages can realize energy transmission and distribution, and finally realize the high-power precision balance of the battery pack. The actual equalization work is carried out by the main control chip MCU, and the inverter with ultra-low dynamic impedance obtains more than 8A equalization current. Precise transformer technology and fully symmetrical circuit design can achieve the equalization effect of  $\leq 30\text{mV}$ .

### Packing list

- ① Active equalization module x1
- ② Line sequence detection board x1
- ③ 3.81 cable interface x1
- ④ Slotted screwdriver x1
- ⑤  $0.5\text{mm}^2$  electronic wire x1

# BALANCE-824(8A)

## Lithium Battery Pack transformer Inverter Active Equalization Module

# User Manual

The 824 equalizer adopts high-frequency transformer inversion and equipotential isolation coupling energy technology to realize the parallel connection of each series of batteries through equipotential isolation coupling. Based on the parallel connection state, each series of batteries with different high and low voltages realize energy transmission and distribution, and finally realize the high-efficiency and precise balance of the battery pack. The Taiwan main control chip MCU combines with the ultra-low dynamic impedance inverter to obtain the more than 8A balanced current. The precise transformer process and fully symmetrical circuit design can achieve the balanced effect of  $\leq 30\text{mV}$ .

It is suitable for high-capacity ternary lithium battery pack and lithium iron phosphate battery pack, etc. The maximum equalizing current can reach 8A, and the equalizing voltage difference can reach  $10\sim 30\text{mV}$ ; Forced start switch is added to better solve the problem of poor equalization effect.

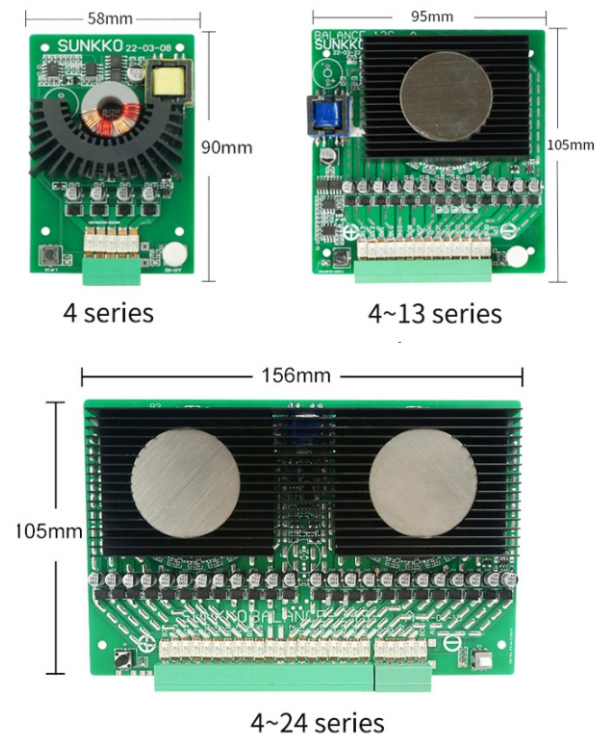

## Product features

1. Nano amorphous isolated fully symmetrical transformer ensures the minimum voltage difference;
2. American ultra-low internal resistance MOS devices constitute an ultra-low dynamic impedance inverter circuit. Achieve high power balance;
3. The control and management of intelligent MCU chip realize automatic self balancing;
4. Automatically detect the minimum voltage of the battery, stop working when the battery energy is low, and protect the battery from power loss;
5. Overcurrent fuse resistance at each series input end to ensure safety;
6. With automatic / manual trigger dual mode;
7. Manual forced equalization timing off function, easy to use;
8. Heat dissipation design of inverter under extreme equilibrium state of high voltage difference.
9. Miniature circuit breaker device for over temperature and over-current protection, control the instantaneous abnormal excessive current, disconnect at over temperature, protect the normal and continuous balance of the battery pack.

## Technical parameter

Product Name:Lithium battery pack transformer inverter active equalization module  
Applicable battery type: Lithium ternary battery / Lithium iron phosphate  
Applicable battery strings:Bal-804:4S;Bal-813:4~13S;Bal-824: 4 ~ 24S.  
Best balance effect: 0.01 ~ 0.02V  
Recommended equalizing battery voltage: above 3.2V  
Equalizing current: 0 ~ 8A  
Interface:3.81  
Low voltage automatic shutdown: 2.7V(2.5V)/series  
Equalization mode: parallel energy transfer mode  
Power consumption of standby load: < 5ma12v (power supply of the fourth series)  
Power consumption in battery balance state after startup: 80ma (Voltage difference=10mv)  
Auto start trigger voltage: +70mv  
Automatic startup and shutdown voltage: +20mv

## Working principle

1. Start mode: When the voltage drop through the protection board reaches 70mV or above (the current is related to the internal resistance of MOS tube on the protection board), the active equalizer automatically starts equalization.
2. Human intervention starts active equilibrium:  
Equalization principle: High voltage energy is transferred to low voltage parallel transmission at the same time to realize battery voltage balance.

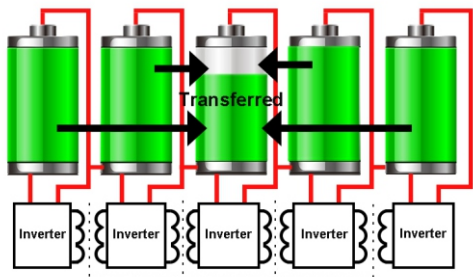

## Explanation of equalizing current, equalizing time, equalizing connection and equalizing minimum differential pressure

1. **The equalization current marked on the equalization module and equalizer is the maximum current that can be output or absorbed by the product, and it is also the maximum current allowed to flow through the chip on the product.**
  2. When the equalizer is actually used to equalize the battery pack, the equalized current is affected by the following factors:
    - ① Internal resistance of battery pack;
    - ② Resistance of connecting cable;
    - ③ Contact resistance of connector;
    - ④ Voltage difference between battery cells (unbalanced condition)
- A: The smaller the internal resistance of battery pack, the greater the equilibrium current  
B: The smaller the resistance of connecting wires and connectors, the greater the equilibrium current  
C: The greater the voltage difference of the battery, the greater the equilibrium current
- 8A current test conditions:  
Voltage difference between batteries  $\geq 0.5V$ , connecting line battery  $< 8m\ \Omega$  (single wire)  
Internal resistance of battery  $\leq 15m\ \Omega$ , connector resistance  $< 4m\ \Omega$
3. Measurement method of equalizing current:  
Since the equalizing current is affected by the loop resistance, the loop resistance will be increased and the equalizing current will be reduced when the ammeter is connected, so the access ammeter is not recommended. In addition, disconnecting the equalizing line during normal equalizing operation will lead to the risk of battery short circuit and damage to the equalizer. Therefore, the test current can only be measured by DC Clamp ammeter.
  4. Equilibrium time correlation
    - A: Under the condition of the same internal resistance of battery, if it can work in equilibrium with the maximum current, the time will be shorter, and the smaller the resistance of connecting line and connector, the shorter the time will be.
    - B: The equalization time of high-capacity battery pack will be longer.
    - C: The smaller the equalizing voltage difference, the longer the time.
    - D: In the final stage of equalization, the voltage difference is very small, so the current is also very small, this period takes a long time.
    - E: When active continuous online equalization is adopted, the equalization state is ideal, and the battery voltage difference can also be controlled between 30mv-80mv. You don't need to pay attention to time by this way.

About the connection of equalizer and battery pack:

1. The connection mode of the connector on the equalizer product is based on the convenience of users' installation and use. However, because the connector has a contact resistance of 3~10m $\Omega$ , each string of batteries will increase  $2 \times 3 \sim 10 = 6 \sim 20m\ \Omega$ , which will greatly reduce the equalization current. Therefore, it is recommended to cancel the connector and connect it directly with wires;
2. Larger cross-sectional area and shorter connection shall be adopted as far as possible for the connecting wire between the battery pack and the battery pack;
3. When direct wire connection is adopted, one end of the equalizer must be welded first, and the battery pack end shall be connected (welded) when it is firmly welded. Pay attention to prevent short circuit between wires during operation!
4. In order to obtain a larger balanced current value, it is recommended to use 0.5mm<sup>2</sup>/A when selecting the connecting wire. If the equalizer is far away from the battery pack and needs to be extended, the conductor section needs to be increased proportionally.

## Expand function-cascade connection

More than 24 strings of battery packs can be cascaded with 2 or more active equalizers. The following is the wiring schematic diagram of the cascade connection of the 32-string and 46-string battery packs. There must be multiple strings of repeated connections, and the more repeated strings, the better the effect.

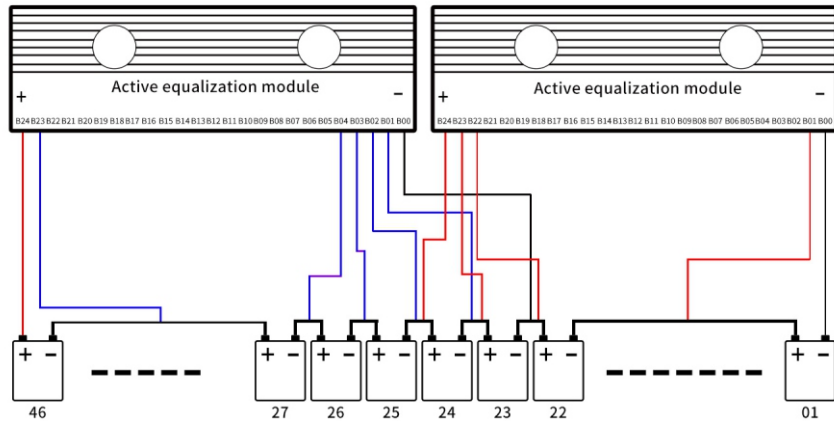
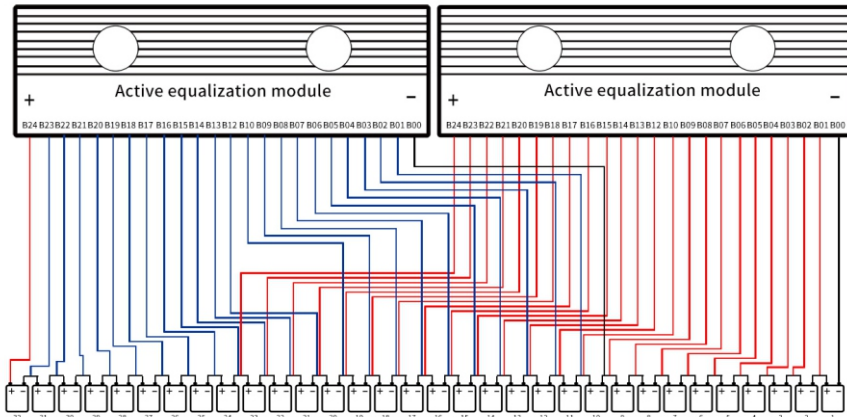

Two active balancers —The max number of strings of battery pack is 25S~44S,  
 Three active balancers —The max number of strings of battery pack is 45S~64S,  
 Four active balancers —The max number of strings of battery pack is 65S~84S,  
 Five active balancers —The max number of strings of battery pack is 85S~104S,  
 Six active balancers —The max number of strings of battery pack is 105S~124S,  
 Seven active balancers —The max number of strings of battery pack is 105S~124S,  
 And so on, that can "cascade" infinitely.

## Two equilibrium model

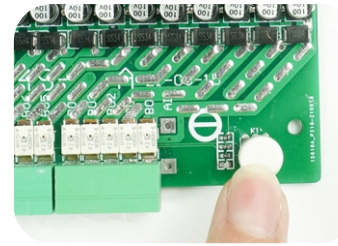

### 1. Continuous equilibrium model

When the white self-locking switch is off, connect the wiring in sequence to ensure correct wiring sequence, press the self-locking switch to start the continuous equalization mode.

On continuous equalization, negative pole LED lighting and positive pole LED flickering. After equalization stop the equalizer manually.

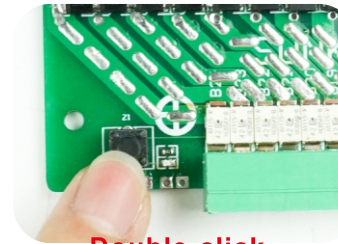

Double-click

### 2. Forced equilibrium mode

When the self-locking switch is off, connect the wiring in sequence to ensure correct wiring sequence. Double click the black touch switch on the left to start the forced equalization mode and it will stop automatically after one hour.

On timed equalization, positive pole LED flickering.

## Wiring diagram with battery pack

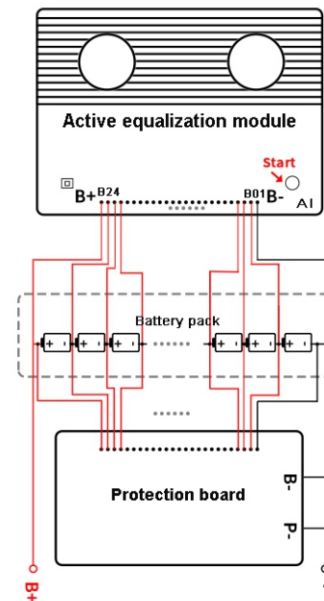

### 1. Manual trigger mode

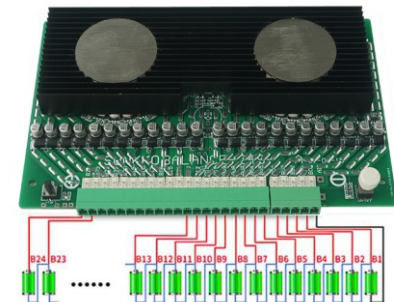

## 2. Automatic trigger mode

When the voltage drop through the protection board reaches 70mv or above (the current is related to the internal resistance of MOS tube on the protection board), the active equalizer automatically starts equalization

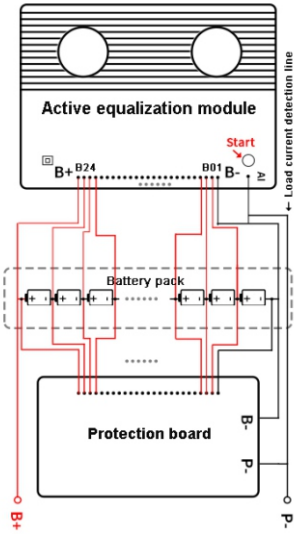

## Test line sequence

### Line sequence detection board

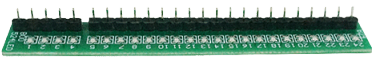

Before connecting the equalizing board, be sure to use the distributed line sequence test board to test whether the wiring sequence is wrong. The wrong line sequence will lead to the damage of the equalizing board. In that case, the board cannot be returned and replaced. Please pay attention.

### Line sequence correct connection display

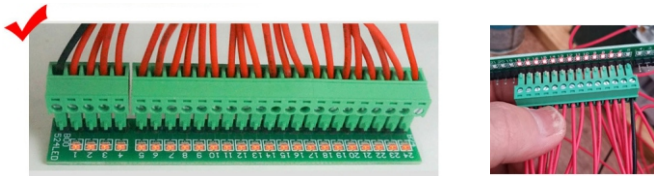

When the positive and negative wire sequence of the battery pack is correctly connected, the corresponding LED light is red



Reverse polarity display



When the sequence connection of two strings of wires is reversed, it shows the balanced arrangement of wires.

## Operation introduction

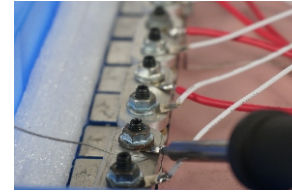

Connect the positive pole of the battery pack in line sequence

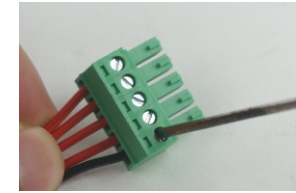

Connect the wire to the socket of 3.81 and pay attention to the locking screw



Test line sequence with the detection board

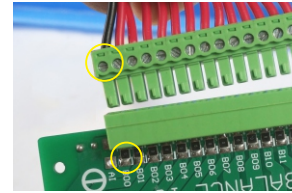

Pay attention the interface B0 connect the negative pole (black)

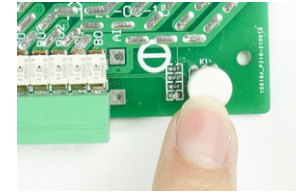

Press the white self-locking switch to start the continuous equalization

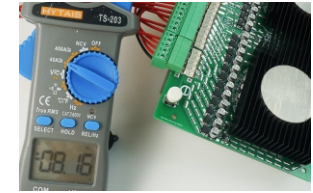

Monitor the equalizing current real time with a digital clamp meter

**Because the battery pack BMS protection cable is signal line for monitoring voltage. Overcurrent < 2A, affect the balanced effect. Therefore, suggest re-weld the cable  $\geq 0.5\text{mm}^2$ .**

## Battery pack descending string cable diagram

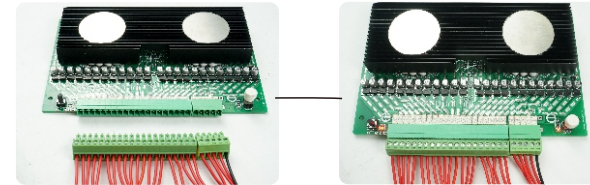

**24S cable diagram:** Black cable (terminal negative) connection B-, other cables are connected in line sequence.

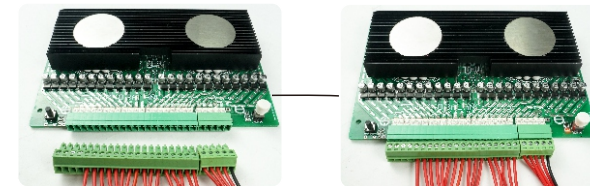

**20S cable diagram:** If connect 20S battery, the extra space in the back is not connected